

PRODUKT: PRODUCT	PROFIL STALOWY STEEL PROFILE
KATEGORIA: CATEGORY	PROFILE OKIENNO-DRZWIOWE_ WZMOCNIENIA WINDOW REINFORCEMENTS
NR PRODUKTU: PRODUCT NO	PROFINE V407
SUROWIEC: RAW MATERIAL	STAL OCYNKOWANA_ DX51D Z100-275 GALVANIZED
GRUPA: GROUP	PROFILE SZCZELINOWE GAP PROFILES
WYMIARY: DIMENSIONS	20 x 25
GRUBOŚĆ: THICKNESS	1,5
DŁUGOŚĆ: LENGHT	STANDARDOWO 6 M DŁUGOŚCI LUB WG ZAMÓWIENIA THE STANDARD INCLUDES 6 METERS OF LENGTH OR AS PER ORDER
OPIS: DESCRIPTION	PROFIL WYKORZYSTYWANY DO WZMOCNIENÍ OKIENNYCH THE PROFILE USED FOR WINDOW OR DOOR REINFORCEMENT

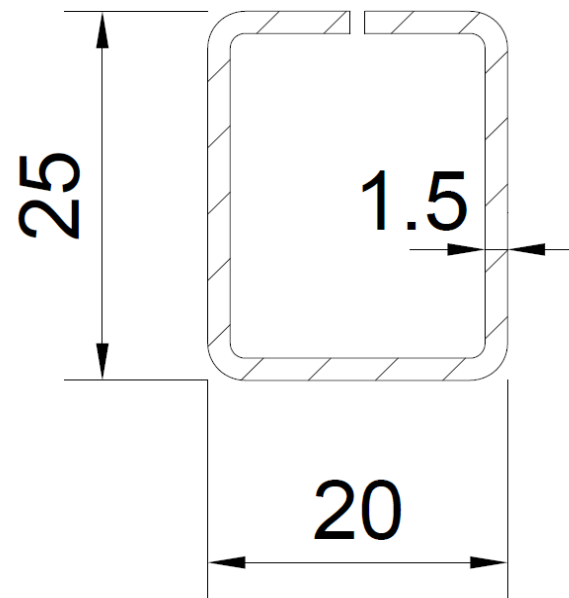

V407

